

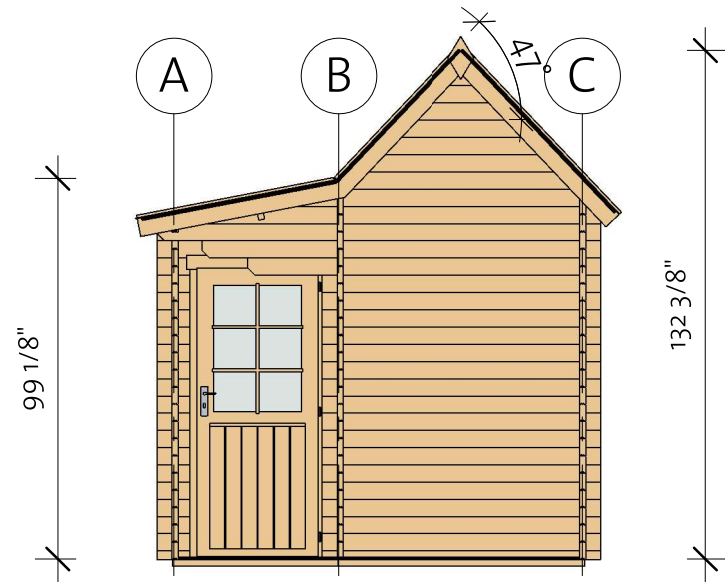

Laker Shed 1 9/16" (10 13/16" 17 7/8")

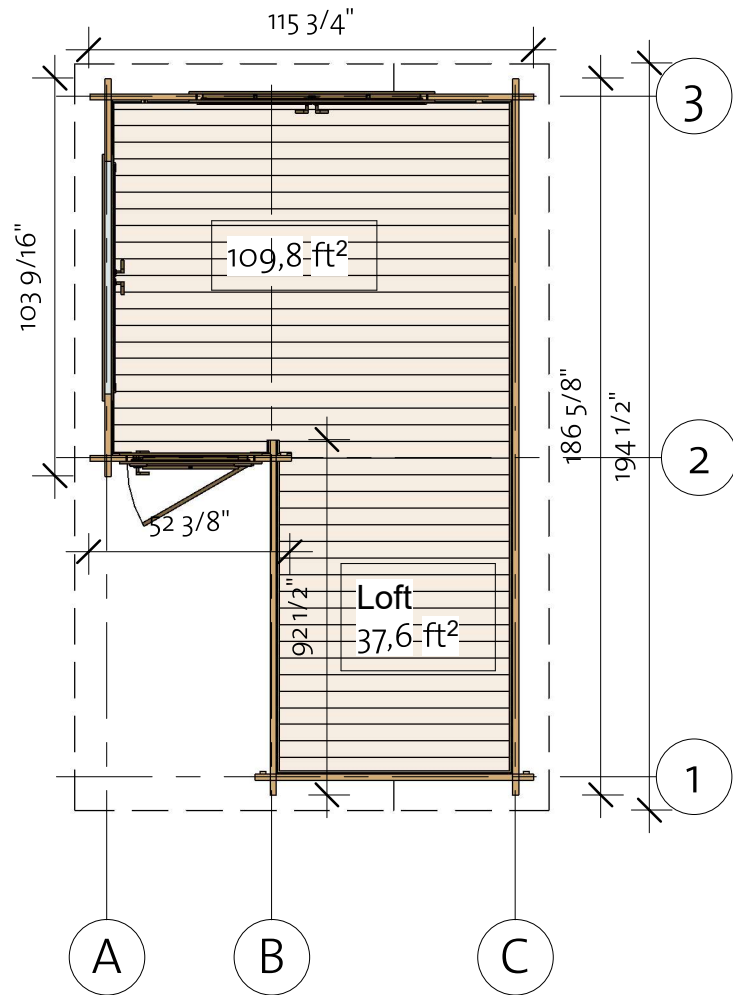
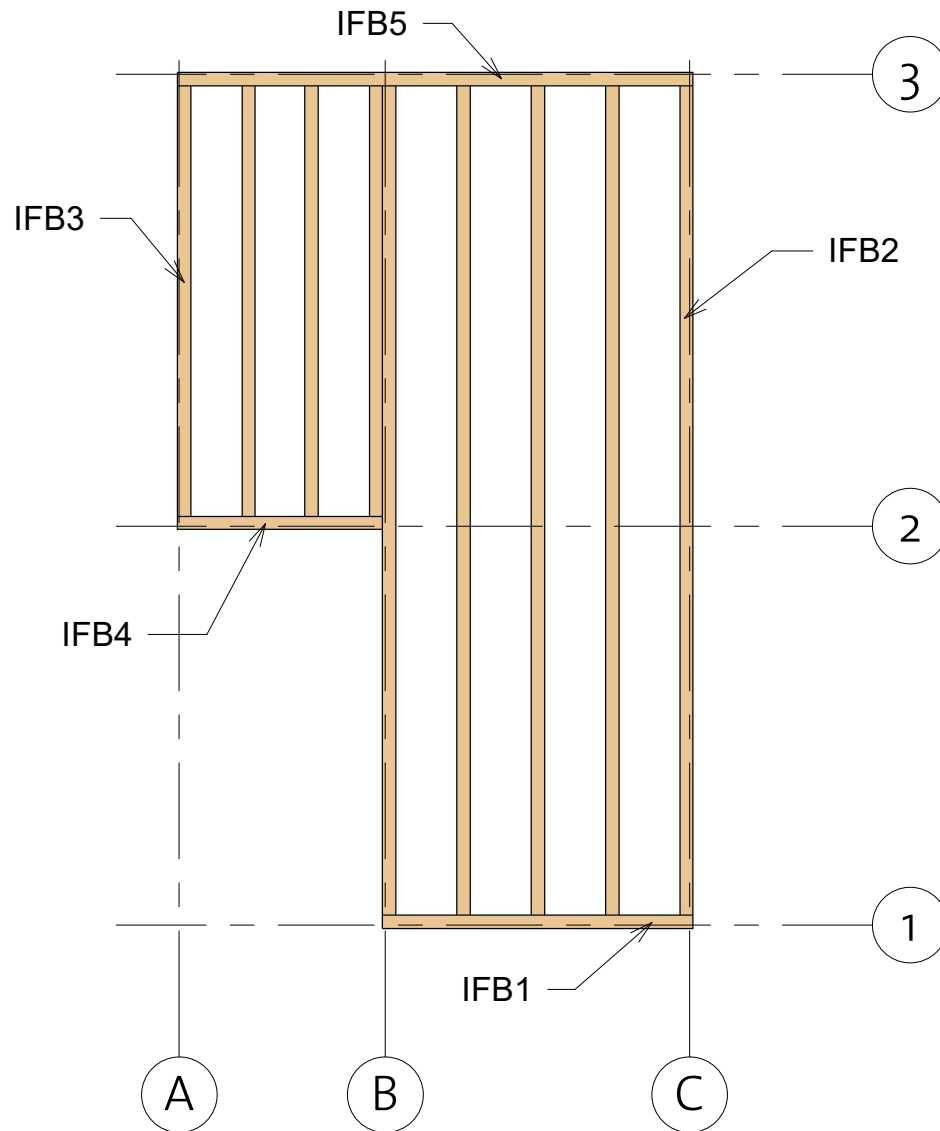

Laker Shed 1 9/16" (10 13/16"17 7/8")

Foundation



| Impregnated foundation beams | | | | |
|------------------------------|-----------|---|-------|------------|
| Mark | Type | Profile | Count | Length |
| IFB1 | IFB 70x45 |  | 1 | 64 9/16" |
| IFB2 | IFB 70x45 | | 5 | 172 13/16" |
| IFB3 | IFB 70x45 | | 4 | 89 3/4" |
| IFB4 | IFB 70x45 | | 1 | 42 15/16" |
| IFB5 | IFB 70x45 | | 1 | 107 1/2" |

Laker Shed 1 9/16" (10 13/16" 17 7/8")

Floor Plan

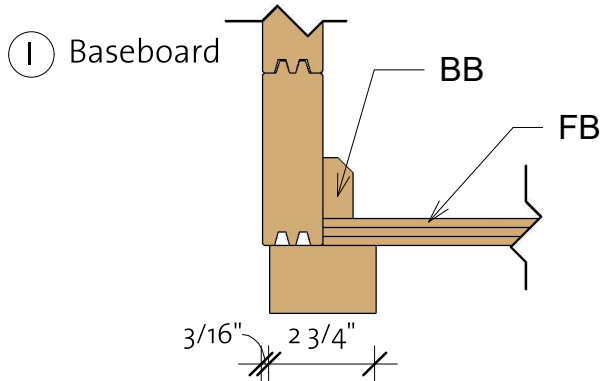

Floor Schedule

| Mark | Type | Profile | Count | Length |
|------|------|---------|-------|--------|
|------|------|---------|-------|--------|

| | | | | |
|-----|-----------|--|----|----------|
| FB1 | FB 18x110 | | 20 | 61 5/8" |
| FB2 | FB 18x110 | | 23 | 104 1/2" |
| FB3 | FB 18x110 | | 7 | 83 1/16" |
| FB4 | FB 18x110 | | 10 | 81 5/16" |

| | | | | |
|-----|----------|--|---|-----------|
| BB1 | BB 20x40 | | 2 | 189" |
| BB2 | BB 20x40 | | 2 | 169 5/16" |
| BB3 | BB 20x40 | | 2 | 118 1/8" |

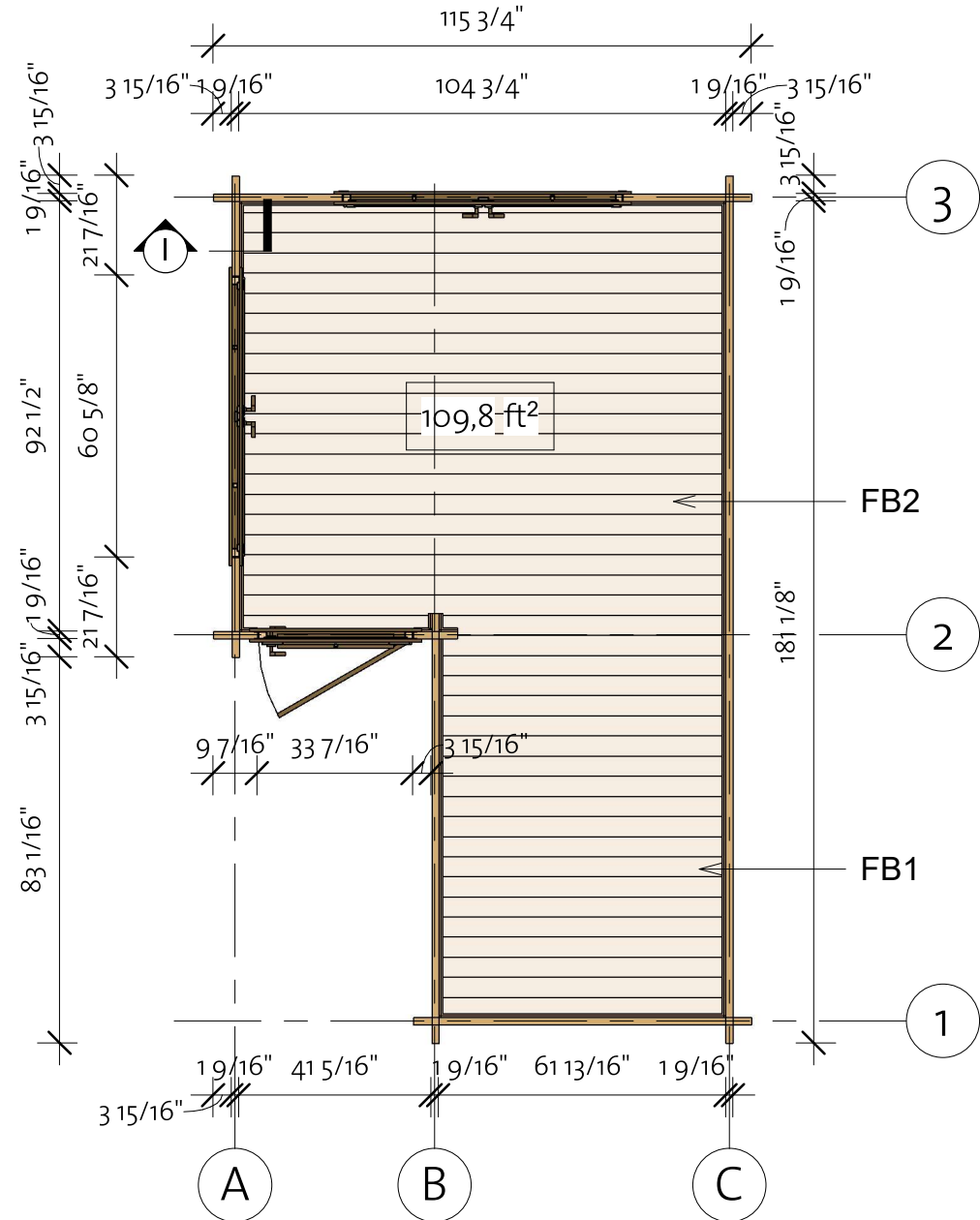

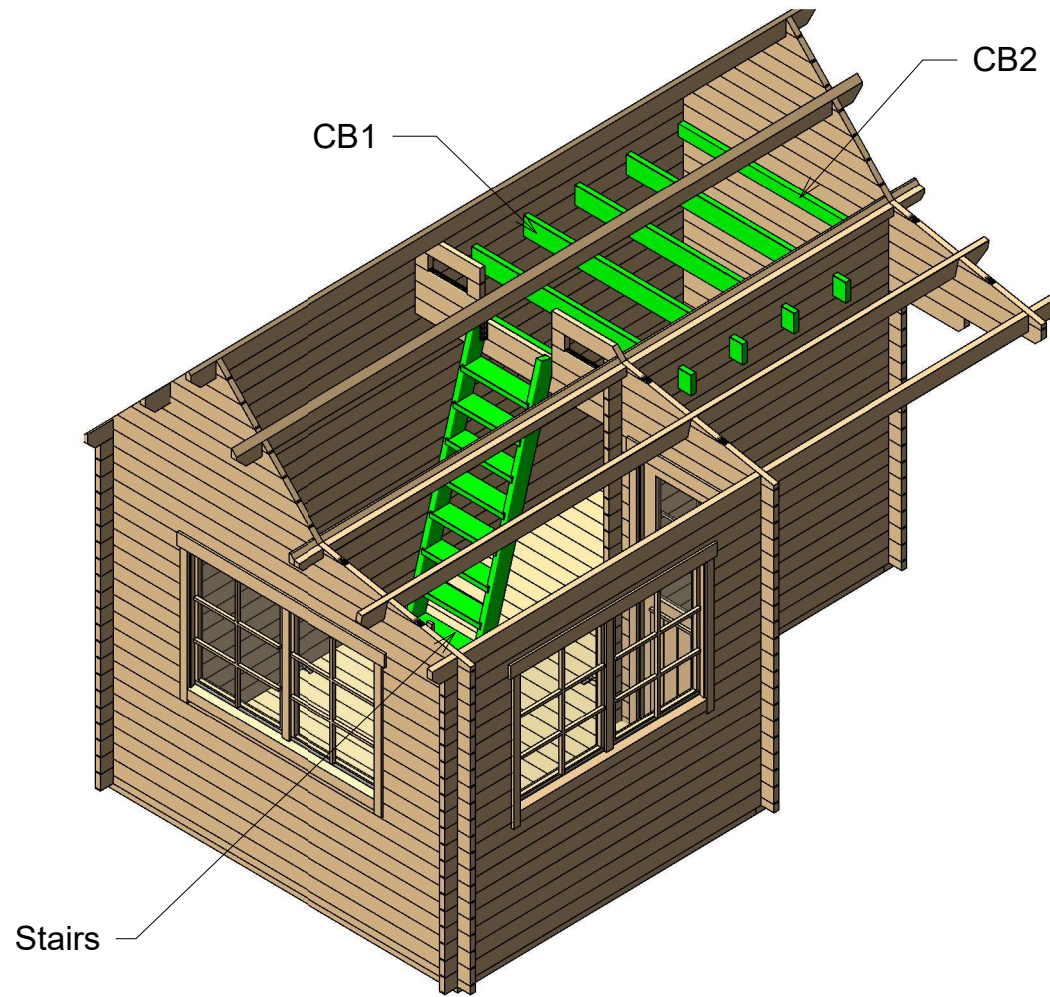

Laker Shed 1 9/16" (10 13/16"17 7/8")

Second floor



| Second floor | | | | |
|--------------|------|---------|-------|------------|
| Mark | Type | Profile | Count | Cut Length |

| | | | | |
|-----|-----------------------|---|---|--------------|
| CB1 | Ceiling beam 4x143 |  | 4 | 72 13/16" |
| CB2 | Ceiling beam 4x90 |  | 2 | 61 11/16" |

Laker Shed 1 9/16" (10 13/16" 17 7/8")

Wall 1

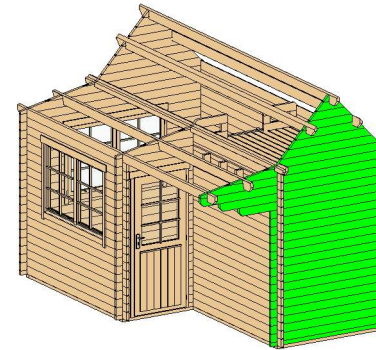
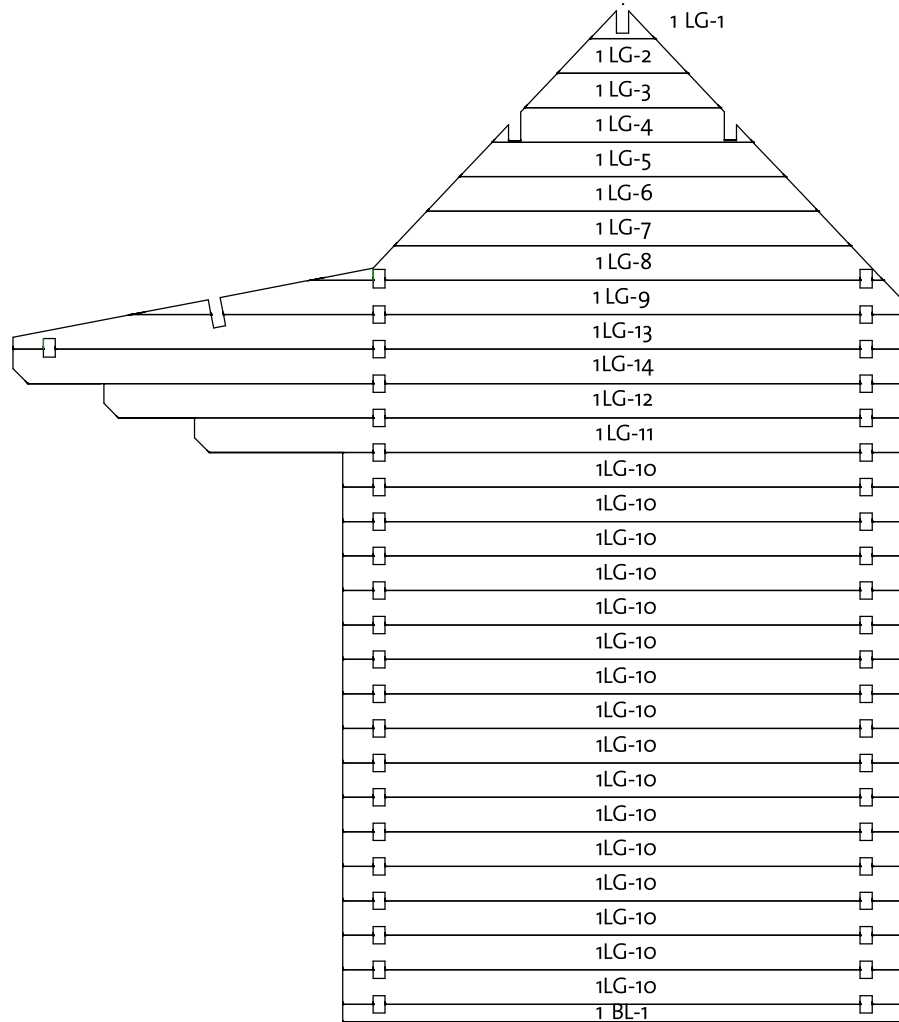

| Wall 1 | | | |
|--------|---------|-------|------------|
| Mark | Profile | Count | Cut Length |

| | | | |
|--------|--------|----|------------|
| 1BL-1 | 40X57 | 1 | 72 13/16" |
| 1LG-1 | 40X114 | 1 | 8 1/2" |
| 1LG-2* | 40X114 | 1 | 17" |
| 1LG-3* | 40X114 | 1 | 25 1/2" |
| 1LG-4* | 40X114 | 1 | 33 15/16" |
| 1LG-5* | 40X114 | 1 | 42 7/16" |
| 1LG-6* | 40X114 | 1 | 50 15/16" |
| 1LG-7* | 40X114 | 1 | 59 7/16" |
| 1LG-8* | 40X114 | 1 | 74 9/16" |
| 1LG-9* | 40X114 | 1 | 100 7/16" |
| 1LG-10 | 40X114 | 16 | 72 13/16" |
| 1LG-11 | 40X114 | 1 | 92 1/8" |
| 1LG-12 | 40X114 | 1 | 103 15/16" |
| 1LG-13 | 40X114 | 1 | 115 3/4" |
| 1LG-14 | 40X114 | 1 | 115 3/4" |

* Gable - delivered premounted

| Log Profile Wall 1 | |
|--------------------|---------|
| Profile | Profile |

| Log Profile Wall 1 | |
|--------------------|---------|
| Profile | Profile |

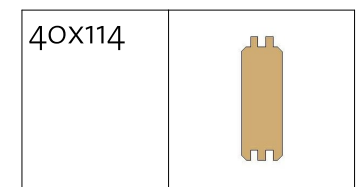
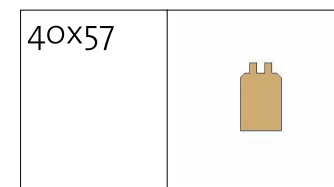

Laker Shed 1 9/16" (10 13/16" 17 7/8")

Wall 2

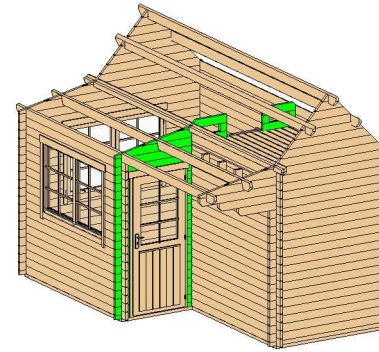

| Wall 2 | | | |
|--------|---------|-------|------------|
| Mark | Profile | Count | Cut Length |

| | | | |
|--------|--------|----|-----------|
| 2BL-1 | 40X57 | 2 | 9 7/16" |
| 2LG-1 | 40X114 | 1 | 37" |
| 2LG-2 | 40X114 | 34 | 9 7/16" |
| 2LG-3 | 40X114 | 1 | 68 5/16" |
| 2LG-4 | 40X114 | 1 | 115 3/4" |
| 2LG-5 | 40X114 | 1 | 115 3/4" |
| 2LG-6 | 40X114 | 1 | 25 3/8" |
| 2LG-7 | 40X114 | 2 | 3 15/16" |
| 2LG-8 | 40X114 | 1 | 9 7/16" |
| 2LG-9 | 40X114 | 1 | 29 9/16" |
| 2LG-10 | 40X114 | 1 | 22 15/16" |

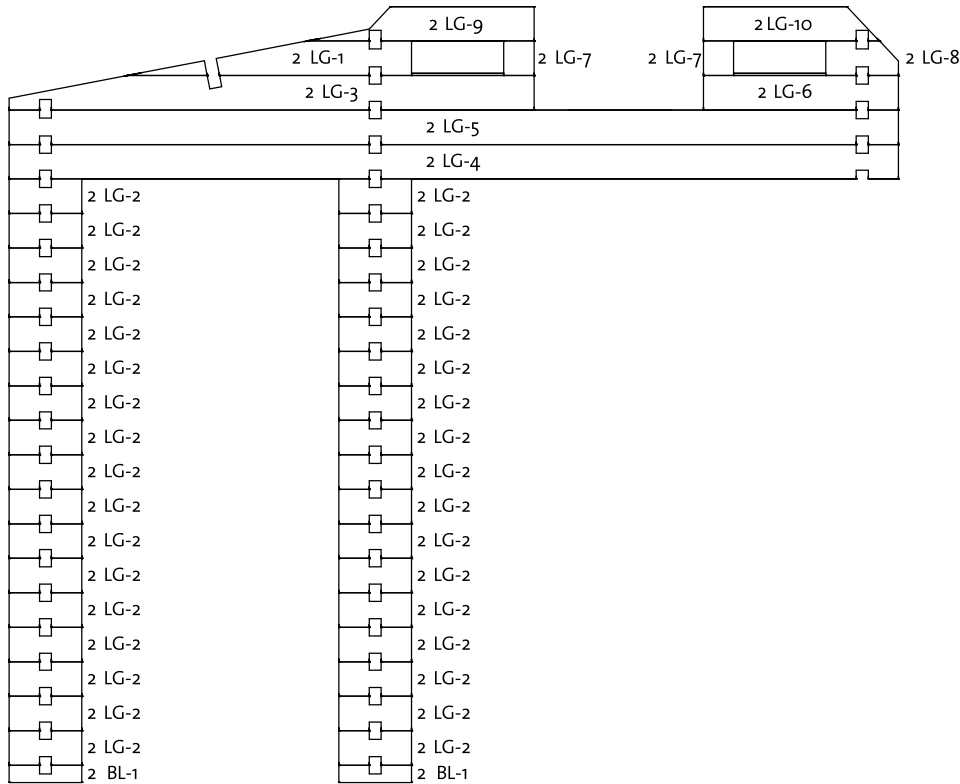

| Log Profile Wall 2 | |
|--------------------|---------|
| Profile | Profile |

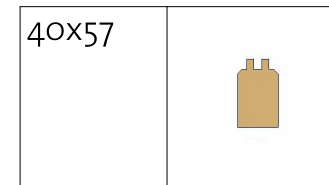

| Log Profile Wall 2 | |
|--------------------|---------|
| Profile | Profile |

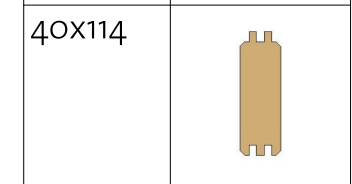
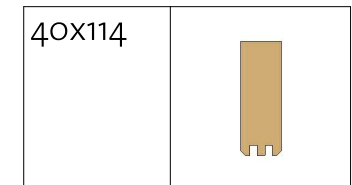

Laker Shed 1 9/16" (10 13/16" 17 7/8")

Wall 3

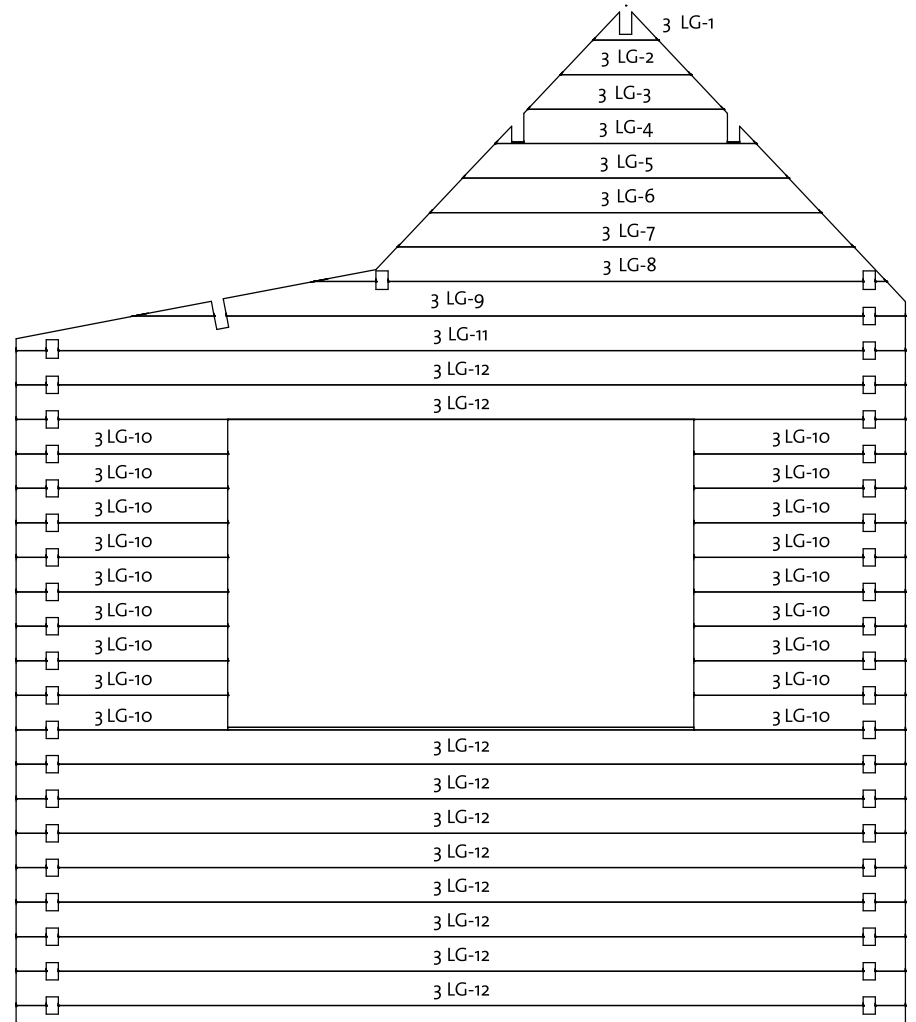
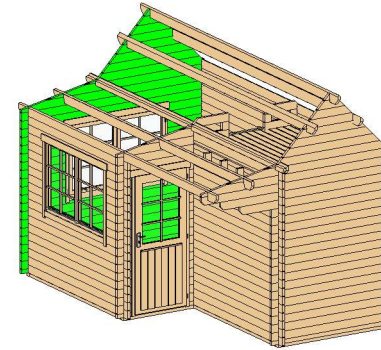

| Wall 3 | | | |
|--------|---------|-------|------------|
| Mark | Profile | Count | Cut Length |

| | | | |
|--------|--------|----|-----------|
| 3BL-1 | 40X57 | 1 | 115 3/4" |
| 3LG-1* | 40X114 | 1 | 8 1/2" |
| 3LG-2* | 40X114 | 1 | 17" |
| 3LG-3* | 40X114 | 1 | 25 1/2" |
| 3LG-4* | 40X114 | 1 | 33 15/16" |
| 3LG-5* | 40X114 | 1 | 42 7/16" |
| 3LG-6* | 40X114 | 1 | 50 15/16" |
| 3LG-7* | 40X114 | 1 | 59 7/16" |
| 3LG-8* | 40X114 | 1 | 74 9/16" |
| 3LG-9 | 40X114 | 1 | 100 7/16" |
| 3LG-10 | 40X114 | 18 | 27 9/16" |
| 3LG-11 | 40X114 | 1 | 115 3/4" |
| 3LG-12 | 40X114 | 10 | 115 3/4" |

* Gable - delivered premounted

| Log Profile Wall 3 | |
|--------------------|---------|
| Profile | Profile |

| Log Profile Wall 3 | |
|--------------------|---------|
| Profile | Profile |

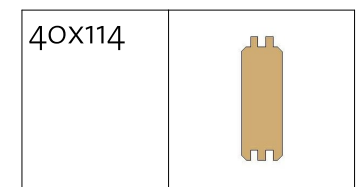
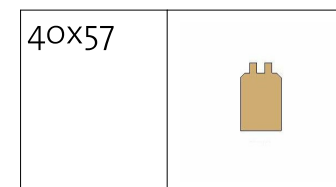

Laker Shed 1 9/16" (10 13/16" 17 7/8")

Wall A

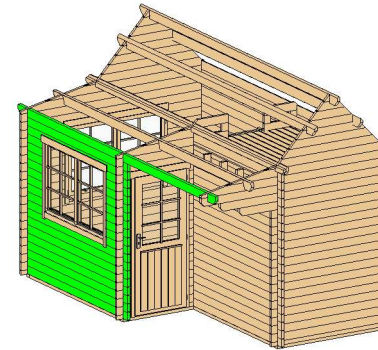

| Wall A | | | |
|--------|---------|-------|------------|
| Mark | Profile | Count | Cut Length |

| | | | |
|-------|--------|----|-----------|
| ALG-1 | 40x114 | 16 | 21 7/16" |
| ALG-2 | 40x114 | 9 | 103 9/16" |
| ALG-3 | 40x114 | 1 | 103 9/16" |
| ALG-4 | 40x114 | 1 | 103 9/16" |
| ATL-1 | 40x123 | 1 | 194 1/2" |

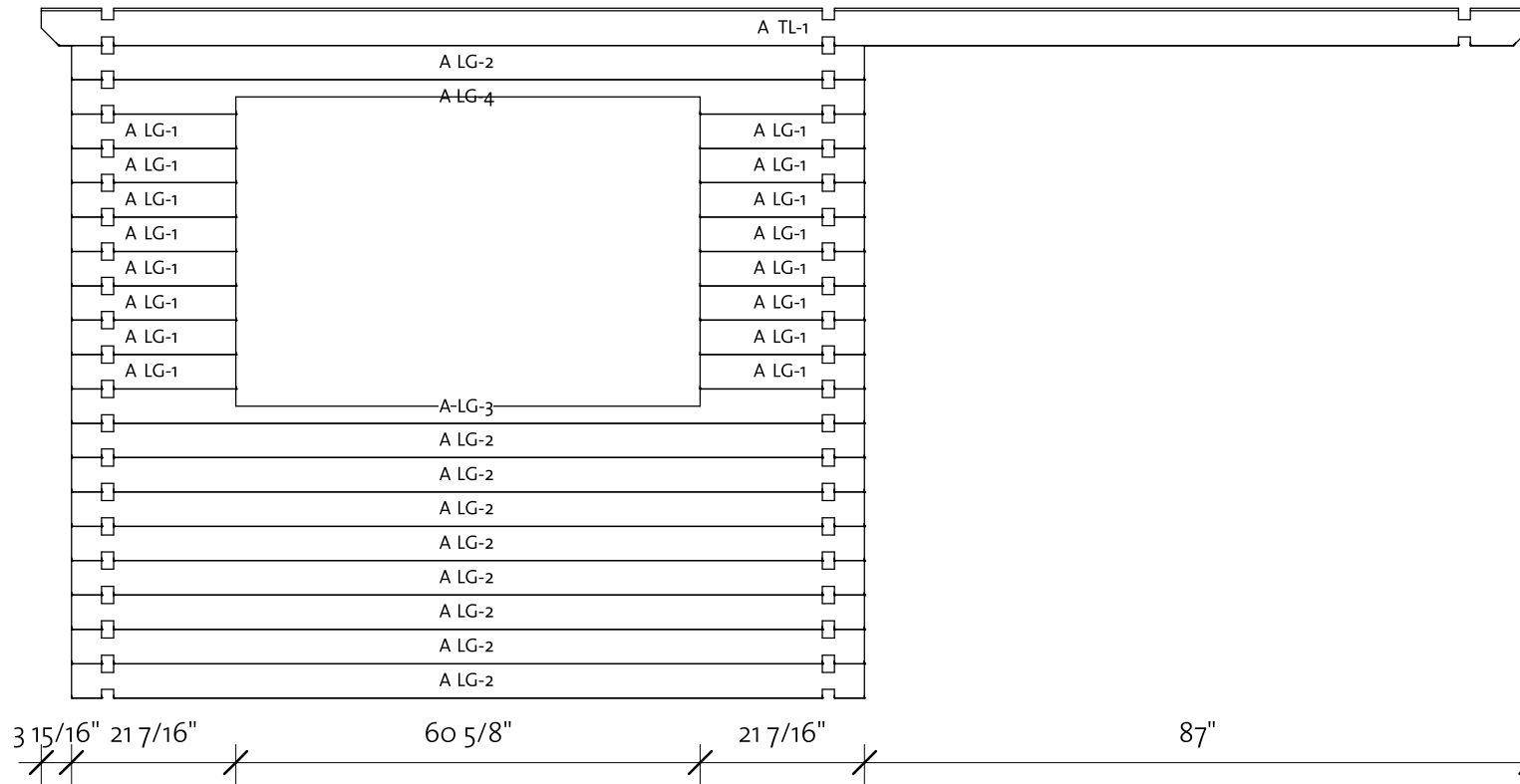

| Log Profile Wall A | |
|--------------------|---------|
| Profile | Profile |

| | |
|--------|--|
| 40x114 | |
| 40x123 | |

Laker Shed 1 9/16" (10 13/16"17 7/8")

Wall B

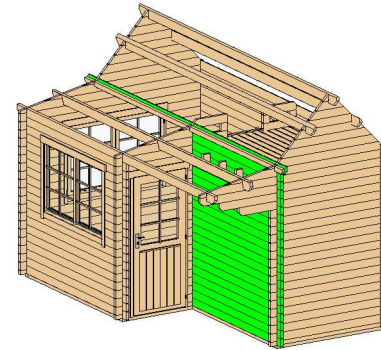

| Wall B | | | |
|--------|---------|-------|------------|
| Mark | Profile | Count | Cut Length |

| | | | |
|-------|--------|----|----------|
| BLG-1 | 4OX114 | 19 | 92 1/2" |
| BLG-2 | 4OX114 | 1 | 92 1/2" |
| BLG-3 | 4OX114 | 1 | 92 1/2" |
| BTL-1 | 4OX123 | 1 | 194 1/2" |

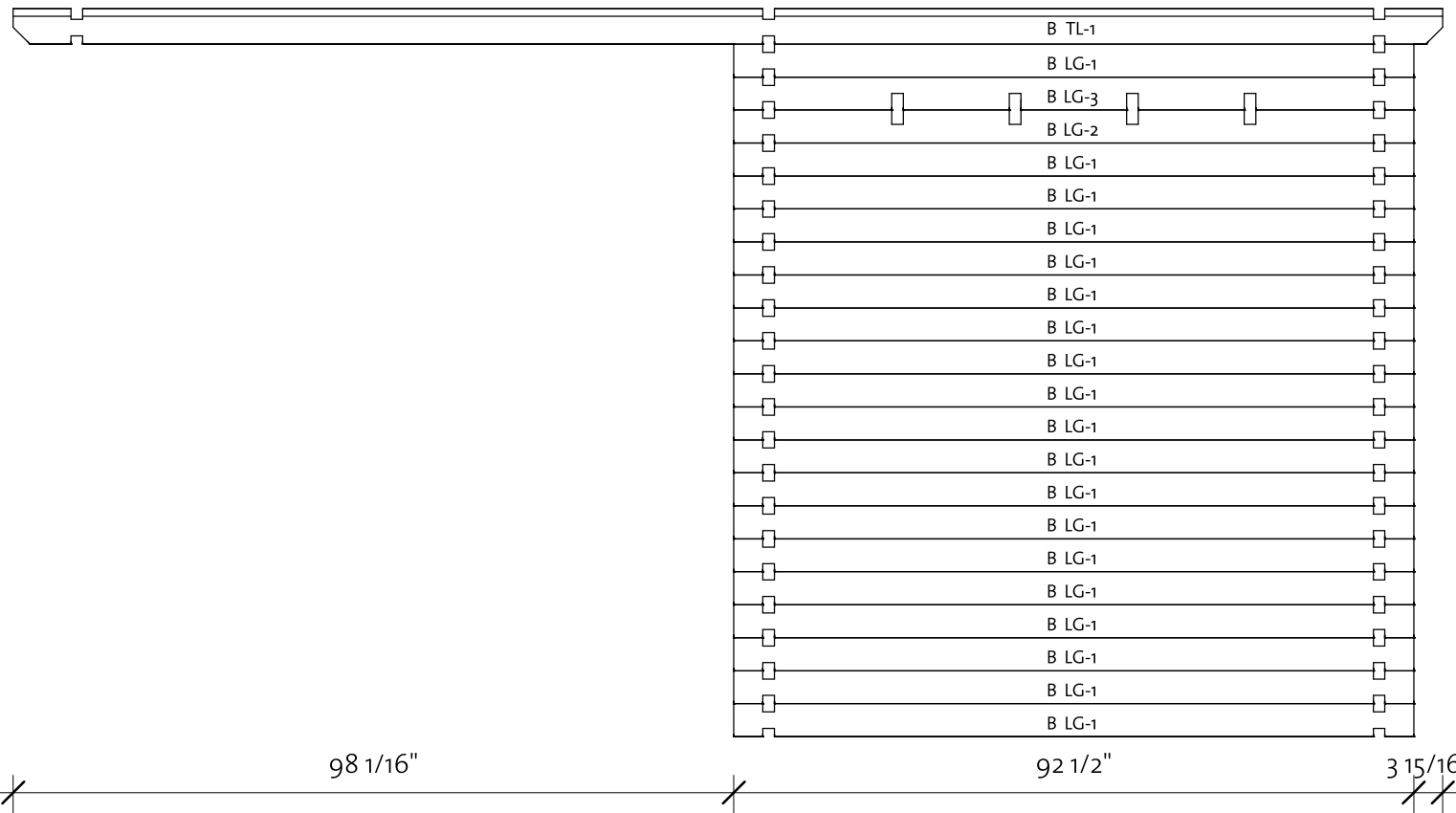

| Log Profile Wall B | |
|--------------------|---------|
| Profile | Profile |

| | |
|--------|--|
| 4OX114 | |
| 4OX123 | |

Laker Shed 1 9/16" (10 13/16"17 7/8")

Wall C

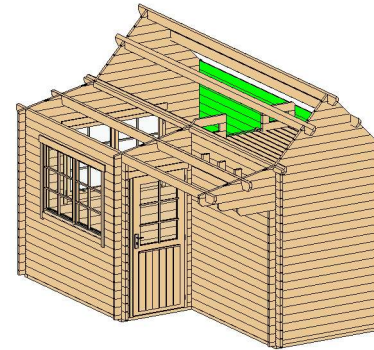

| Wall C | | | |
|--------|---------|-------|------------|
| Mark | Profile | Count | Cut Length |

| | | | |
|-------|--------|----|----------|
| CLG-1 | 40x114 | 17 | 186 5/8" |
| CLG-2 | 40x114 | 1 | 186 5/8" |
| CLG-3 | 40x114 | 1 | 186 5/8" |
| CLG-4 | 40x114 | 1 | 186 5/8" |
| CLG-5 | 40x114 | 1 | 186 5/8" |
| CTL-1 | 40x123 | 1 | 194 1/2" |

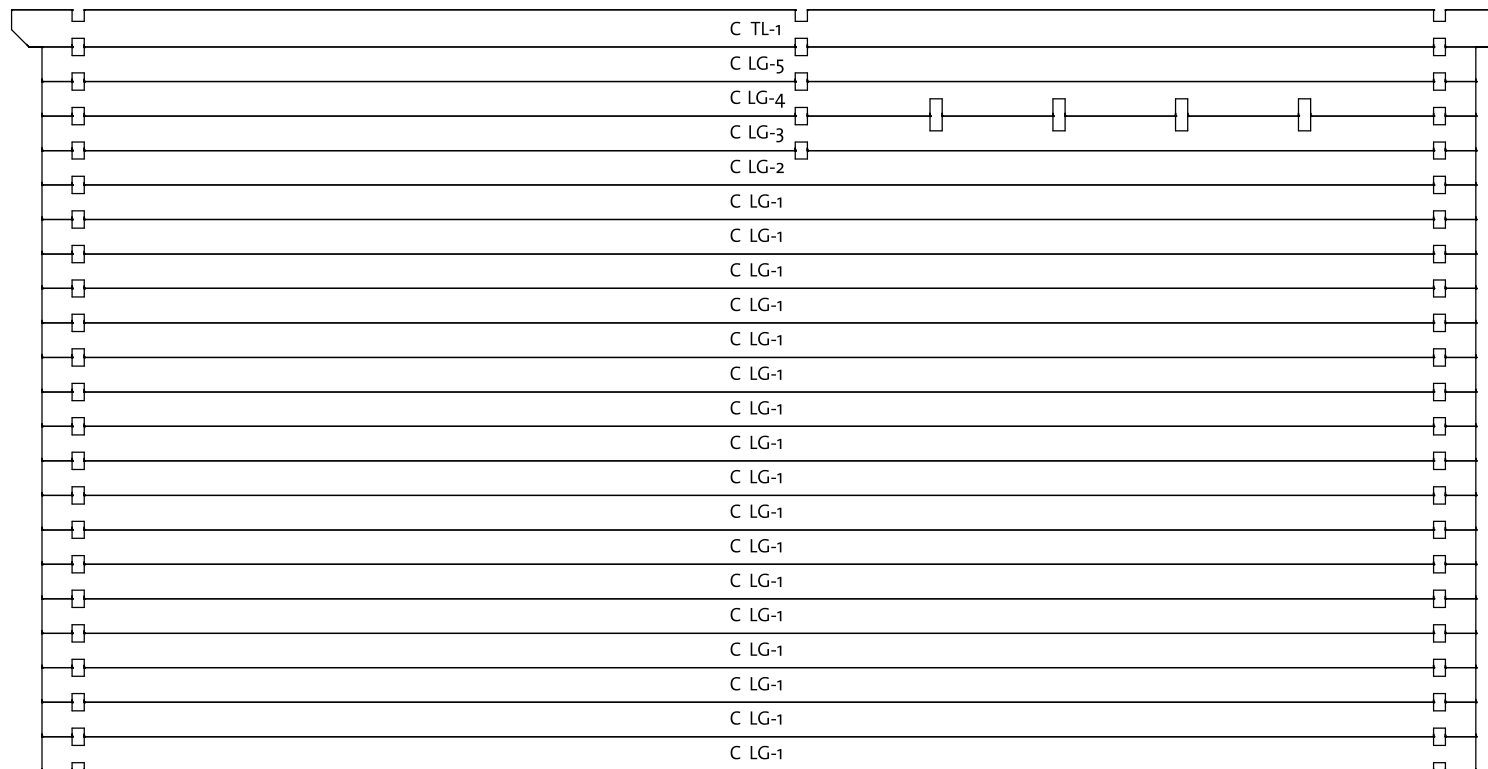





| Log Profile Wall C | |
|--------------------|---------|
| Profile | Profile |

| | |
|--------|--|
| 40x114 | |
| 40x123 | |

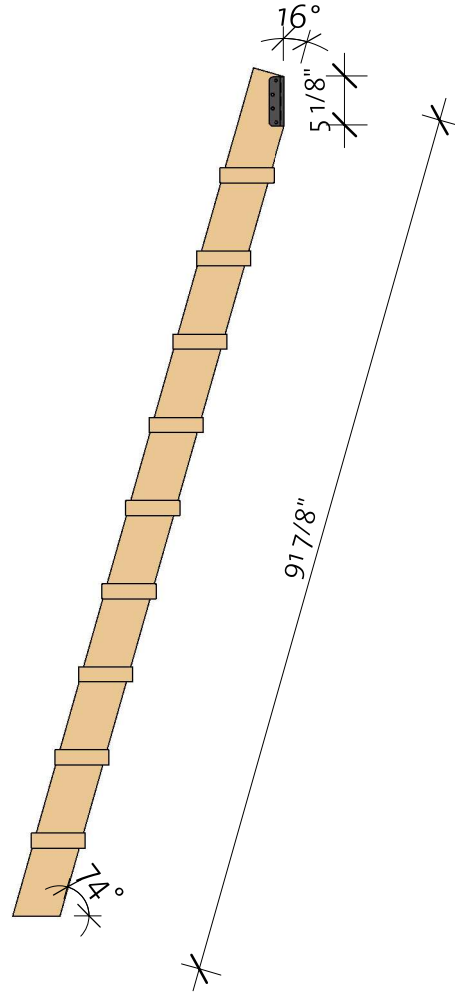
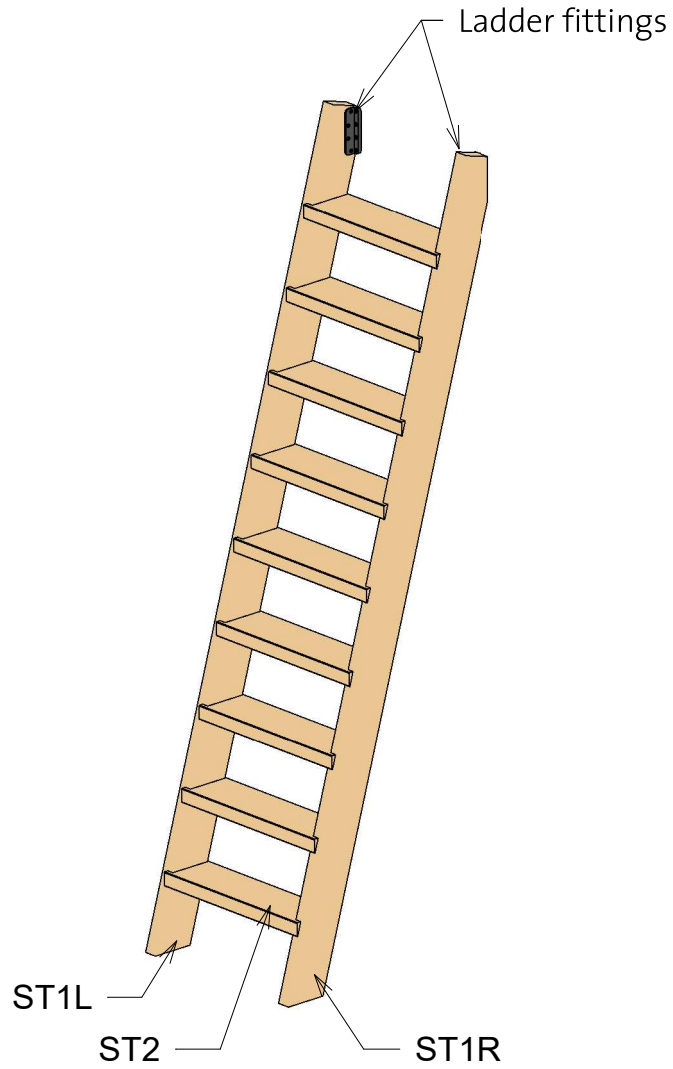
Laker Shed 1 9/16" (10 13/16"17 7/8")

Stair



| Stair | | | | |
|-------|--------------|---|-------|------------|
| Mark | Profile | Profile | Count | Cut Length |
| ST1R | Stair 40X120 |  | 1 | 91 7/8" |
| ST1L | Stair 40X120 |  | 1 | 91 7/8" |
| ST2 | Stair 143X40 |  | 9 | 20 1/2" |

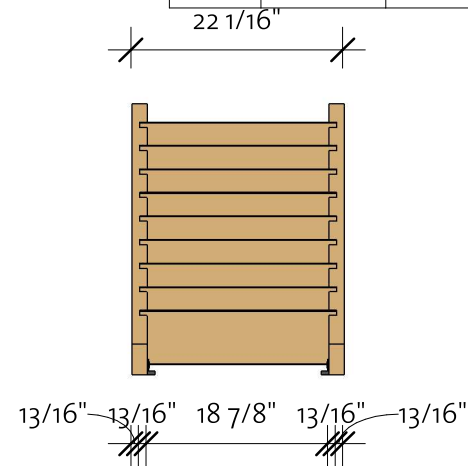

Laker Shed 1 9/16" (10 13/16"17 7/8")

Roof 1

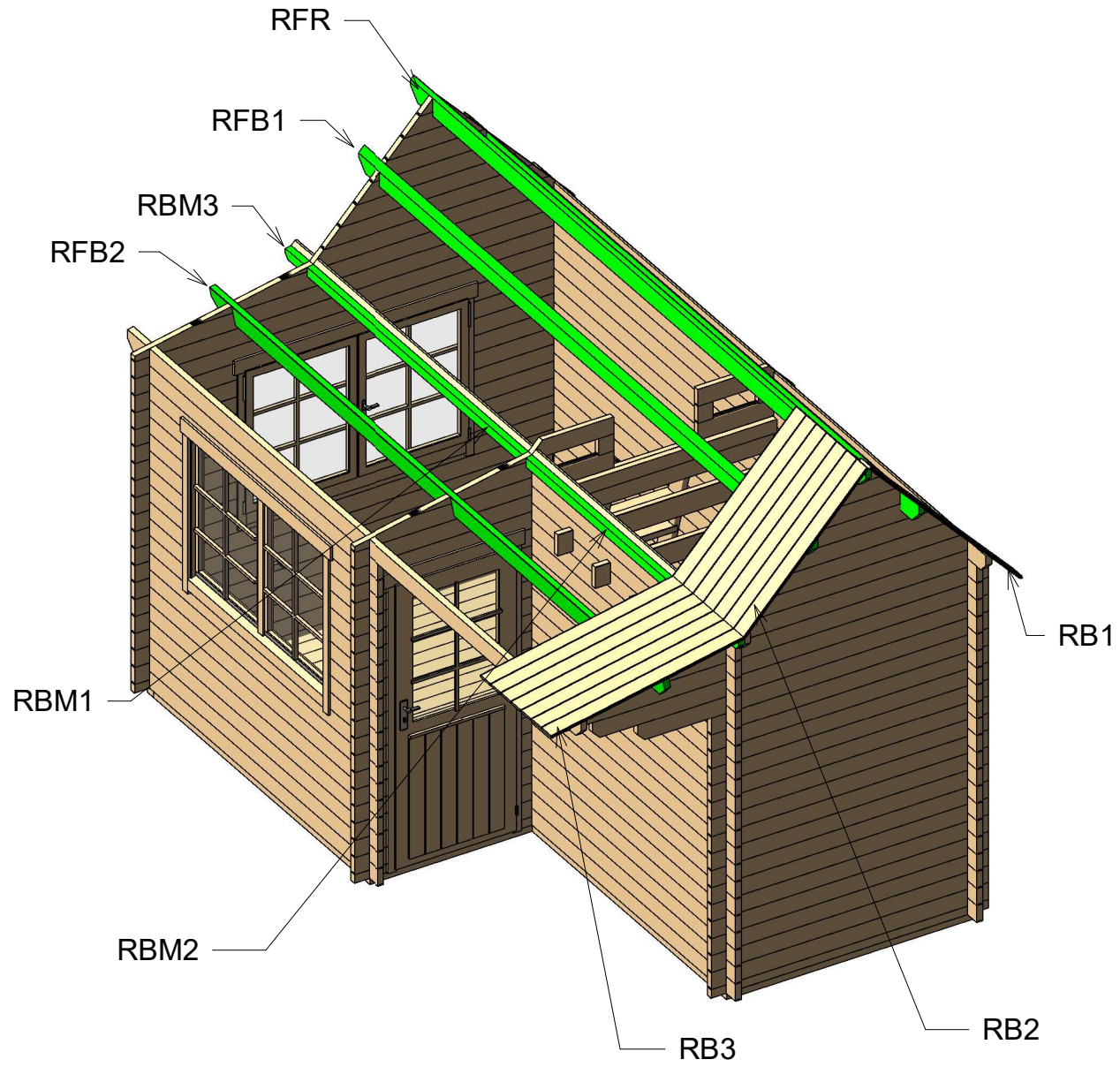

| Roof | | | | |
|------|-----------------|---------|-------|-----------|
| Mark | Type | Profile | Count | Length |
| RB1 | 18x110 | | 46 | 58 3/4" |
| RB2 | 18x110 | | 46 | 47 13/16" |
| RB3 | 18x110 | | 46 | 51 1/2" |
| RBM1 | Roof beam 40x70 | | 1 | 92 1/2" |
| RBM2 | Roof beam 40x70 | | 1 | 81 1/2" |
| RBM3 | Roof beam 40x70 | | 1 | 77/8" |
| RBM4 | Roof beam 40x70 | | 1 | 77/8" |
| RFB1 | Beam 40x143 | | 2 | 194 1/2" |
| RFB2 | Beam 40x143 | | 1 | 194 1/2" |
| RFR | Ridge 40x143 | | 1 | 194 1/2" |

Laker Shed 1 9/16" (10 13/16"17 7/8")

Roof 2

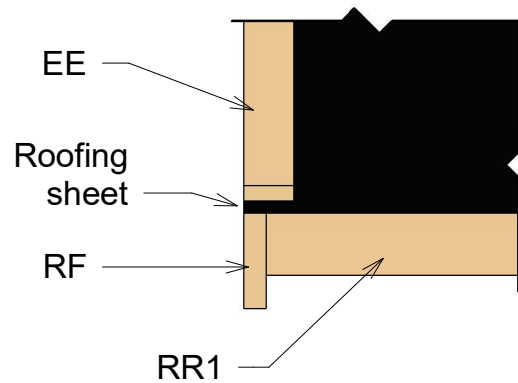
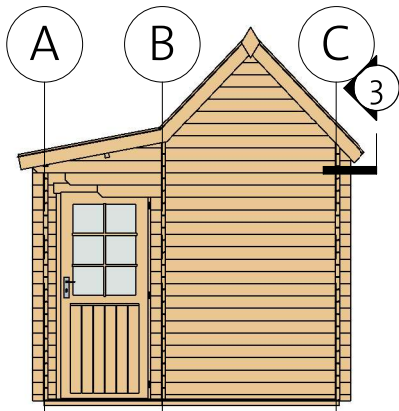
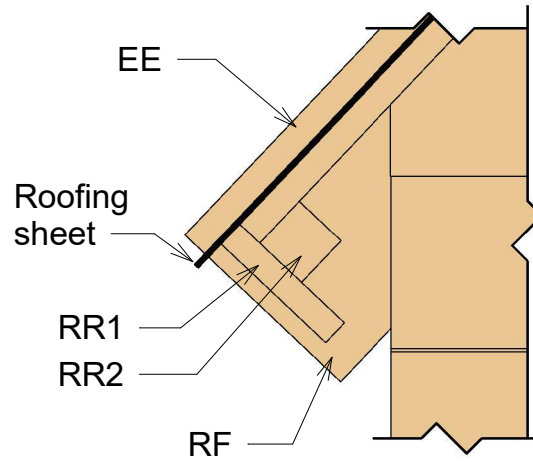
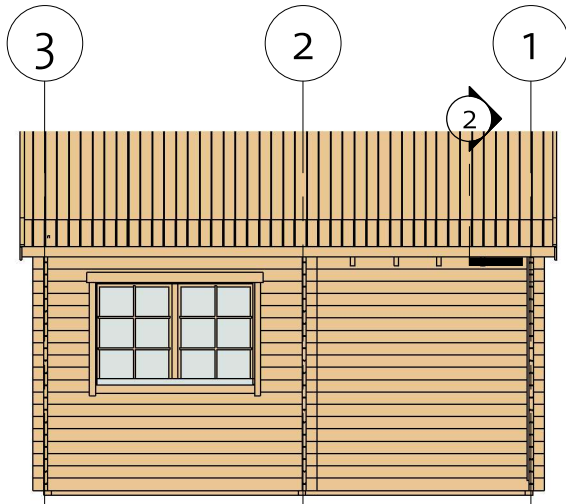

| Fascia Schedule | | | | |
|-----------------|------|---------|-------|--------|
| Mark | Type | Profile | Count | Length |

| | | | | |
|-----|--------------------------------|--|---|-----------|
| EE1 | Eave Edging 18x40 | | 2 | 59 15/16" |
| EE2 | Eave Edging 18x40 | | 2 | 47 15/16" |
| EE3 | Eave Edging 18x40 | | 2 | 52 1/2" |
| RF1 | Roof Fascia 18x120 | | 2 | 59 15/16" |
| RF2 | Roof Fascia 18x120 | | 2 | 49 5/16" |
| RF3 | Roof Fascia 18x120 | | 2 | 54 1/16" |
| RR1 | Roof reinforcement 18x95 | | 2 | 194 1/2" |
| RR2 | Roof reinforcement 38x38 | | 2 | 194 1/2" |

Laker Shed 1 9/16" (10 13/16"17 7/8")

Extras



| Door Schedule | | | | |
|---------------|-------------------------|-------------|--------------|-------|
| Model | Type | Width | Height | Count |
| CD4R | Classic door 4 right | 33 1/16" | 76 15/16" | 1 |
| DCB6 | Door Crossbar 6 | -- | -- | 1 |

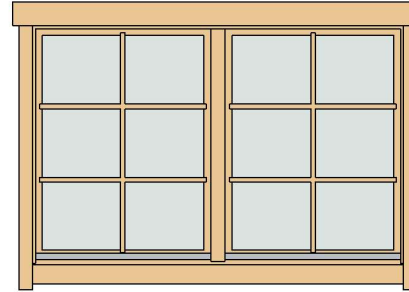

| Window Schedule | | | | |
|-----------------|-------------------------------|--------|------------|-------|
| Mark | Type | Height | Width | Count |
| CDW1 | Classic double window 1 | 39" | 60 1/4" | 2 |
| WCB6 | Windows Crossbar 6 | -- | -- | 4 |

| Fasteners/Extras | | |
|------------------|------|-------|
| Name | Type | Count |

| | | |
|-----------------|-------------------|-----|
| Screws | 3/16" x 2" | 850 |
| Screws | 3/16" x 2 3/4" | 70 |
| Hitblock | 11 13/16"-15 3/4" | |
| Nails | 1/16"x 1 9/16" | 70 |
| Screws | 1/4" x 5 1/2" | 120 |
| Screws | 3/16" x 40 | 130 |
| Bolts | M5/16"x 2 3/4" | 12 |
| Ladder fittings | | 2 |
| Bolts | M5/16"x 3 9/16" | 3 |



| Type | Count |
|------|-------|
| Romb | 2 |





| Type | Count | Length |
|--------------------|-------|---------------|
| Windboard 18x40 | 4 | 103 15/16" |
| Windboard 38x38 | 1 | 103 15/16" |

91903251_191106



Laker Shed 1 9/16" (10 13/16" 17 7/8")

List of all items 1

| Impregnated foundation beams | | | | |
|------------------------------|-----------|---|-------|------------|
| Mark | Type | Profile | Count | Length |
| IFB1 | IFB 70x45 |  | 1 | 64 9/16" |
| IFB2 | IFB 70x45 | | 5 | 172 13/16" |
| IFB3 | IFB 70x45 | | 4 | 89 3/4" |
| IFB4 | IFB 70x45 | | 1 | 42 15/16" |
| IFB5 | IFB 70x45 | | 1 | 107 1/2" |

| Second floor | | | | |
|--------------|------------------------|---|-------|------------|
| Mark | Type | Profile | Count | Cut Length |
| CB1 | Ceiling beam 40x143 |  | 4 | 72 13/16" |
| CB2 | Ceiling beam 40x90 |  | 2 | 61 11/16" |

| Stair | | | | |
|-------|---------|---------|-------|------------|
| Mark | Profile | Profile | Count | Cut Length |





| | | | | |
|------|-----------------|---|---|---------|
| ST1R | Stair 40x120 |  | 1 | 91 7/8" |
| ST1L | Stair 40x120 |  | 1 | 91 7/8" |
| ST2 | Stair 143x40 |  | 9 | 20 1/2" |









| Floor Schedule | | | | |
|----------------|-----------|---|-------|----------|
| Mark | Type | Profile | Count | Length |
| FB1 | FB 18x110 |  | 20 | 61 5/8" |
| FB2 | FB 18x110 | | 23 | 104 1/2" |
| FB3 | FB 18x110 | | 7 | 83 1/16" |
| FB4 | FB 18x110 | | 10 | 81 5/16" |

| | | | | |
|-----|----------|---|---|-----------|
| BB1 | BB 20x40 |  | 2 | 189" |
| BB2 | BB 20x40 | | 2 | 169 5/16" |
| BB3 | BB 20x40 | | 2 | 118 1/8" |

Laker Shed 1 9/16" (10 13/16" 17 7/8")

List of all items 2

| Roof | | | | |
|------|--------------------|---|-------|-----------|
| Mark | Type | Profile | Count | Length |
| RB1 | 18x110 |  | 46 | 58 3/4" |
| RB2 | 18x110 | | 46 | 47 13/16" |
| RB3 | 18x110 | | 46 | 51 1/2" |
| RBM1 | Roof beam 40x70 |  | 1 | 92 1/2" |
| RBM2 | Roof beam 40x70 | | 1 | 81 1/2" |
| RBM3 | Roof beam 40x70 | | 1 | 7 7/8" |
| RBM4 | Roof beam 40x70 | | 1 | 7 7/8" |
| RFB1 | Beam 40x143 |  | 2 | 194 1/2" |
| RFB2 | Beam 40x143 |  | 1 | 194 1/2" |
| RFR | Ridge 40x143 |  | 1 | 194 1/2" |

| Fascia Schedule | | | | |
|-----------------|-----------------------------|---|-------|-----------|
| Mark | Type | Profile | Count | Length |
| EE1 | Eave Edging 18x40 |  | 2 | 59 15/16" |
| EE2 | Eave Edging 18x40 |  | 2 | 47 15/16" |
| EE3 | Eave Edging 18x40 |  | 2 | 52 1/2" |
| RF1 | Roof Fascia 18x120 |  | 2 | 59 15/16" |
| RF2 | Roof Fascia 18x120 |  | 2 | 49 5/16" |
| RF3 | Roof Fascia 18x120 |  | 2 | 54 1/16" |
| RR1 | Roof reinforcement 18x95 |  | 2 | 194 1/2" |
| RR2 | Roof reinforcement 38x38 |  | 2 | 194 1/2" |

Laker Shed 1 9/16" (10 13/16" 17 7/8")

List of all items 3

| Wall 1 | | | |
|--------|---------|-------|------------|
| Mark | Profile | Count | Cut Length |

| | | | |
|--------|--------|----|------------|
| 1BL-1 | 40x57 | 1 | 72 13/16" |
| 1LG-1 | 40x114 | 1 | 8 1/2" |
| 1LG-2* | 40x114 | 1 | 17" |
| 1LG-3* | 40x114 | 1 | 25 1/2" |
| 1LG-4* | 40x114 | 1 | 33 15/16" |
| 1LG-5* | 40x114 | 1 | 42 7/16" |
| 1LG-6* | 40x114 | 1 | 50 15/16" |
| 1LG-7* | 40x114 | 1 | 59 7/16" |
| 1LG-8* | 40x114 | 1 | 74 9/16" |
| 1LG-9* | 40x114 | 1 | 100 7/16" |
| 1LG-10 | 40x114 | 16 | 72 13/16" |
| 1LG-11 | 40x114 | 1 | 92 1/8" |
| 1LG-12 | 40x114 | 1 | 103 15/16" |
| 1LG-13 | 40x114 | 1 | 115 3/4" |
| 1LG-14 | 40x114 | 1 | 115 3/4" |



| Wall 2 | | | |
|--------|---------|-------|------------|
| Mark | Profile | Count | Cut Length |

| | | | |
|--------|--------|----|-----------|
| 2BL-1 | 40x57 | 2 | 9 7/16" |
| 2LG-1 | 40x114 | 1 | 37" |
| 2LG-2 | 40x114 | 34 | 9 7/16" |
| 2LG-3 | 40x114 | 1 | 68 5/16" |
| 2LG-4 | 40x114 | 1 | 115 3/4" |
| 2LG-5 | 40x114 | 1 | 115 3/4" |
| 2LG-6 | 40x114 | 1 | 25 3/8" |
| 2LG-7 | 40x114 | 2 | 3 15/16" |
| 2LG-8 | 40x114 | 1 | 9 7/16" |
| 2LG-9 | 40x114 | 1 | 29 9/16" |
| 2LG-10 | 40x114 | 1 | 22 15/16" |

* Gable - delivered premounted

| Wall 3 | | | |
|--------|---------|-------|------------|
| Mark | Profile | Count | Cut Length |

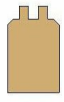
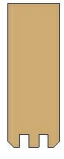
| | | | |
|--------|--------|----|-----------|
| 3BL-1 | 40x57 | 1 | 115 3/4" |
| 3LG-1 | 40x114 | 1 | 8 1/2" |
| 3LG-2 | 40x114 | 1 | 17" |
| 3LG-3 | 40x114 | 1 | 25 1/2" |
| 3LG-4 | 40x114 | 1 | 33 15/16" |
| 3LG-5 | 40x114 | 1 | 42 7/16" |
| 3LG-6 | 40x114 | 1 | 50 15/16" |
| 3LG-7 | 40x114 | 1 | 59 7/16" |
| 3LG-8 | 40x114 | 1 | 74 9/16" |
| 3LG-9 | 40x114 | 1 | 100 7/16" |
| 3LG-10 | 40x114 | 18 | 27 9/16" |
| 3LG-11 | 40x114 | 1 | 115 3/4" |
| 3LG-12 | 40x114 | 10 | 115 3/4" |

| Log Profiles 1 | |
|----------------|---|
| Profile | Profile |
| 40x57 |  |
| 40x114 |  |
| 40x114 |  |

Laker Shed 1 9/16" (10 13/16" 17 7/8")

List of all items 4

| Wall C | | | |
|--------|---------|-------|------------|
| Mark | Profile | Count | Cut Length |

| | | | |
|-------|--------|----|----------|
| CLG-1 | 40X114 | 17 | 186 5/8" |
| CLG-2 | 40X114 | 1 | 186 5/8" |
| CLG-3 | 40X114 | 1 | 186 5/8" |
| CLG-4 | 40X114 | 1 | 186 5/8" |
| CLG-5 | 40X114 | 1 | 186 5/8" |
| CTL-1 | 40X123 | 1 | 194 1/2" |



| Wall B | | | |
|--------|---------|-------|------------|
| Mark | Profile | Count | Cut Length |

| | | | |
|-------|--------|----|----------|
| BLG-1 | 40X114 | 19 | 92 1/2" |
| BLG-2 | 40X114 | 1 | 92 1/2" |
| BLG-3 | 40X114 | 1 | 92 1/2" |
| BTL-1 | 40X123 | 1 | 194 1/2" |

| Wall A | | | |
|--------|---------|-------|------------|
| Mark | Profile | Count | Cut Length |

| | | | |
|-------|--------|----|-----------|
| ALG-1 | 40X114 | 16 | 21 7/16" |
| ALG-2 | 40X114 | 9 | 103 9/16" |
| ALG-3 | 40X114 | 1 | 103 9/16" |
| ALG-4 | 40X114 | 1 | 103 9/16" |
| ATL-1 | 40X123 | 1 | 194 1/2" |

| Log profiles 2 | |
|----------------|---------|
| Profile | Profile |

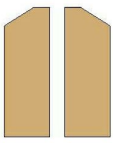
| | |
|--------|--|
| 40X123 |  |
| 40X114 |  |
| 40X114 |  |
| 40X123 |  |